



## DATOS MOTOR

POTENCIA	0.5HP
REVOLUCIONES	1760
FRECUENCIA	60HZ
TORQUE MOTOR NOMINAL	2,1
CARCASA (PAM)	71(B5)
TIPO BRIDA	FF-130
EFICIENCIA MOTOR	IE 2

## DATOS REDUCTOR

REFERENCIA	541018
TIPO	ORTOGONAL
MODELO	FCN
MATERIAL	ALUMINIO
CARCASA	50
RELACION DE TRANSMISION i:	30
VELOCIDAD SALIDA	58,67
TORQUE MAXIMO	83
TORQUE OPERACIÓN	46
FACTOR DE SERVICIO	1,8

## PLANOS REDUCTOR

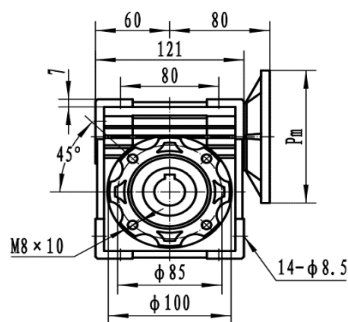

**FCN 50**

Input shaft hole

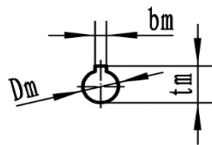

Output shaft hole

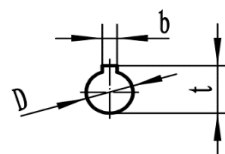

Dimensions of output shaft				
D	H7	b	D10	t
25		8		28.3

	Pm	Dm	bm	tm
63B5	140	11	4	12.8
63B14	90			
71B5	160	14	5	16.3
71B14	105			
80B5	200	19	6	21.8
80B14	120			

